

CATÁLOGO
2023

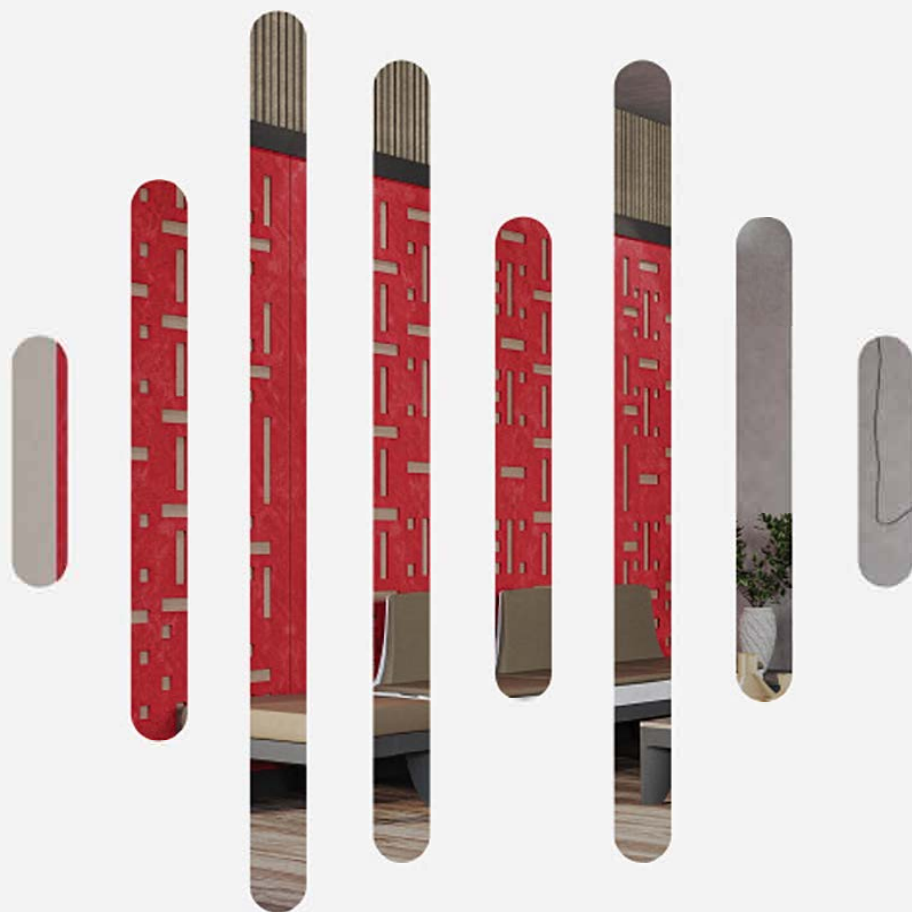

sonara

PANELES ACÚSTICOS

cillo.mx

Presentación	4
Características	6
Ventajas Sonara	7
Ficha Técnica	8
Colores Disponibles	9
Soluciones Sonara	10
Corte Celosía	12
Corte V	20
Corte U	24
Paneles Suspendidos	36
Accesorios	38
Instalación	40

sonara

Llega a innovar la industria de los paneles acústicos

Combinando a la perfección
el interiorismo con la protección
de la contaminación auditiva.



sonara se especializa en la comercialización de paneles acústicos y decorativos para paredes, techos o mamparas divisorias

Es una marca cuya creación se fundamenta en ofrecer soluciones a distintos tipos de proyectos dentro del mercado de la decoración, contract, interiorismo y arquitectura en instalaciones del sector terciario como edificios públicos, auditorios, teatros, oficinas, restaurantes, hoteles y comercios, que requieren de un acondicionamiento interior acústico y de diseño.

Ofreciendo siempre un trato directo y profesional a nivel nacional de asesores técnicos especializados.

Nuestros paneles acústicos están fabricados 100% con fibras de poliéster y no contienen aglutinantes químicos, incluido el formaldehído, garantizando la reducción de la contaminación auditiva gracias a sus propiedades fonoabsorbentes.



CARACTERÍSTICAS



Acústico



Aislante
Térmico

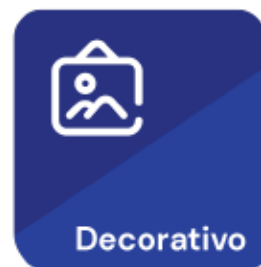

Decorativo



Imprimible



Fácil
Instalación



Ligero



Pinchable



Reciclado



Retardante
al Fuego



No Tóxico



Soluciones personalizadas en medidas y materiales.



Alta especialización en paneles acústicos y decorativos.



Altos Inventarios.



Calidad y certificación.



Diseños innovadores.

VENTAJAS



MATERIAL: Fibra 100% poliéster.
 Contiene un mínimo de 70% de material reciclado.

TIPO DE SUPERFICIE: Suave y se puede conservar durante años.
 No contiene ningún producto químico de la Lista Roja.
 Seguro, no tóxico, no irritante y no alergénico.

DENSIDAD: 1500 g / m2 para 9 mm en stock.

TAMAÑO: 2440 * 1220 * 9 mm (+/- 10%) o tamaño personalizado.

CERTIFICACIONES:

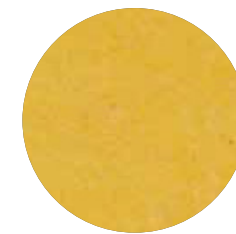

Amarillo

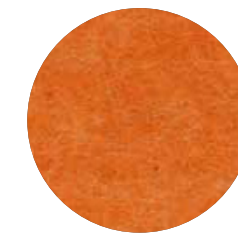

Naranja



Camello



Gris Plateado



Verde

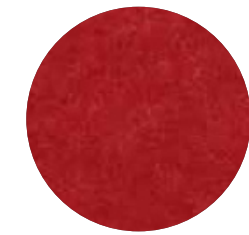

Rojo

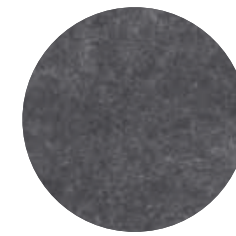

Gris Espacial



Celeste

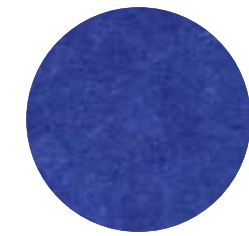

Azul Marino

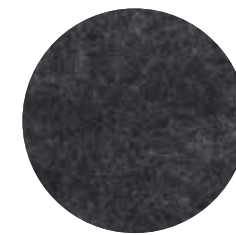

Gris

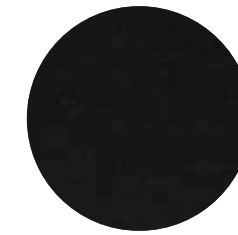

Negro

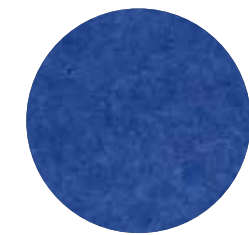

Azul Cielo

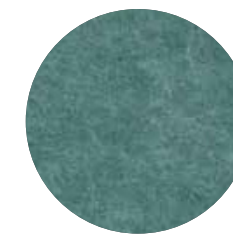

Turquesa

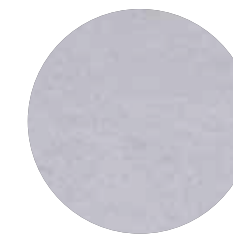

Blanco

Las características físicas y tonalidades de los paneles pueden variar ligeramente del material disponible a surtir por la composición de las fibras así como lotes.





Descubra la flexibilidad de
diseño ilimitada del panel
acústico **Sonara**

Son tan versátiles que se
pueden implementar en:

- Edificios públicos
- Auditorios y Teatros
- Oficinas
- Restaurantes y Hoteles
- Comercios
- Estudios

sonara PANEL

Contamos con un sin fin de combinaciones y así poder plasmar el diseño ideal para tu espacio.

Tamaño de Hoja: 122 x 244 cm.

sonara CUSTOM

La opción que brinda este producto es que tienes la posibilidad de hacer cortes personalizados sobre el panel de tu elección.



El panel tipo celosía de Sonara se puede colgar individualmente o en grupos para segmentar el espacio o pegarlo en la pared, crear interés visual

PANEL TIPO
CELOSÍA





SCC 005

Corte Celosía

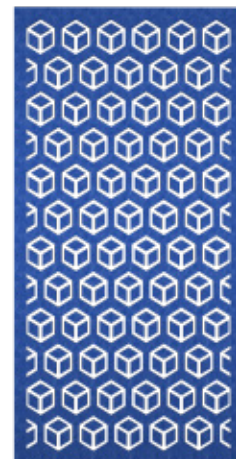

SCC 001

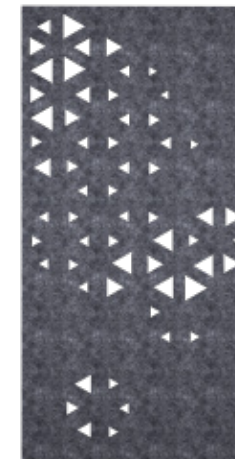

SCC 002



SCC 003



SCC 004



SCC 005

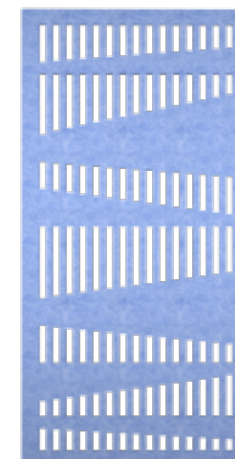

SCC 006



CELOSÍA



Corte Celosía

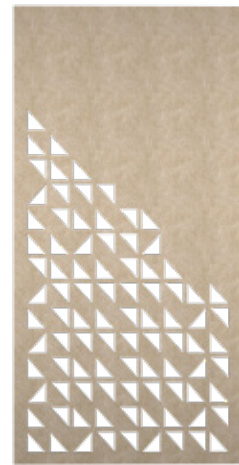

SCC 007

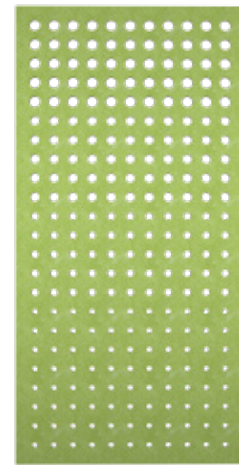

SCC 008

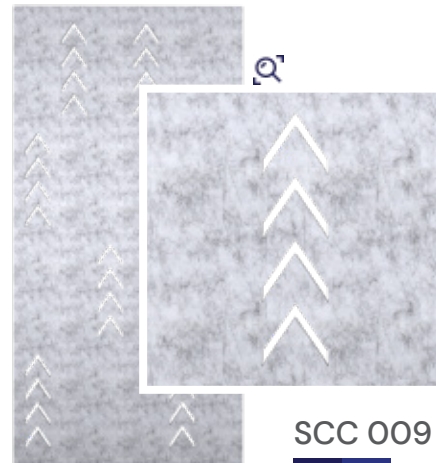

SCC 009

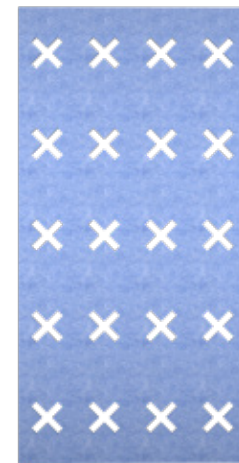

SCC 010

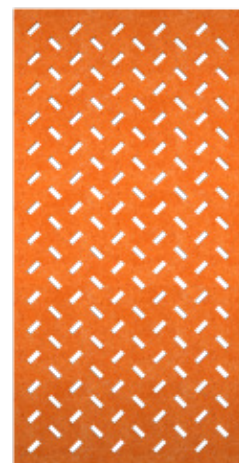

SCC 011

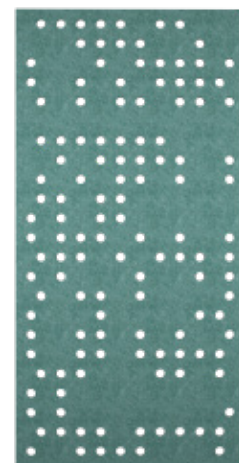

SCC 012

Corte Celosía

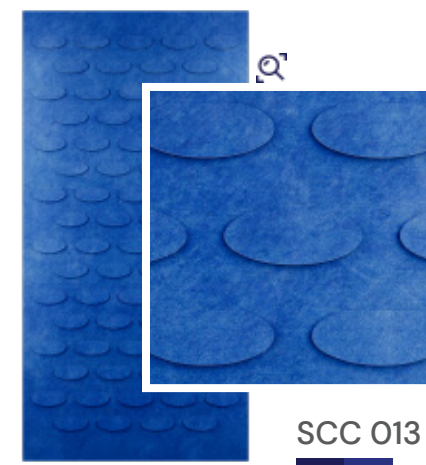

SCC 013

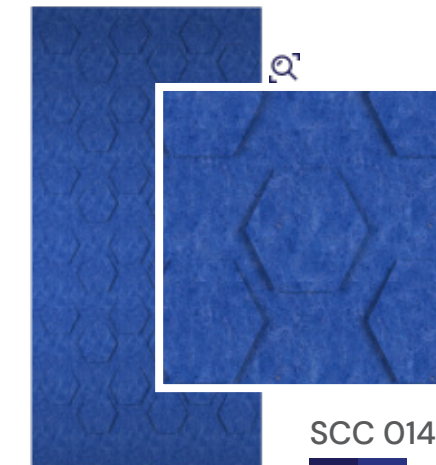

SCC 014

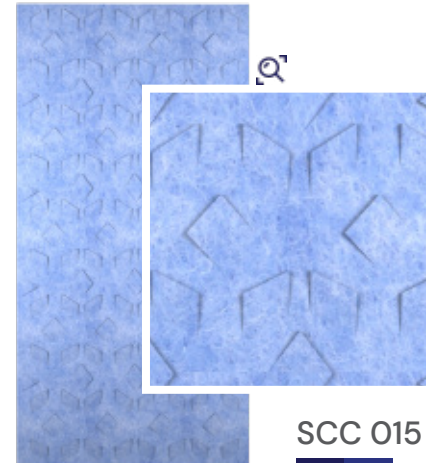

SCC 015

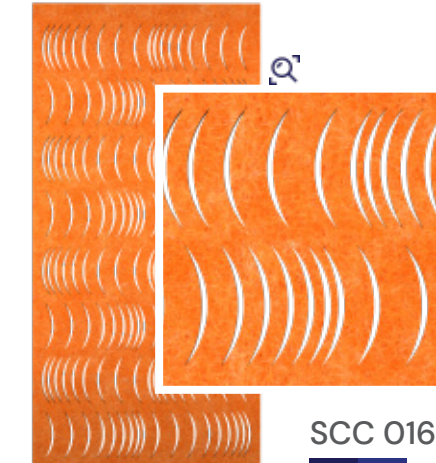

SCC 016

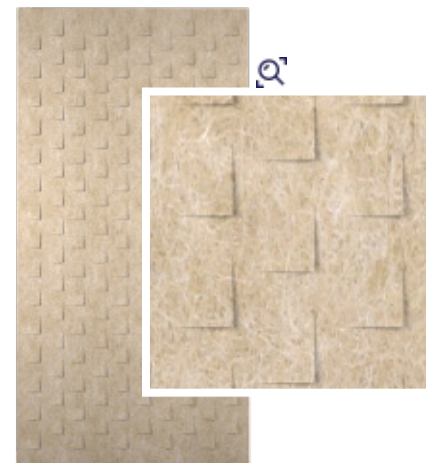

SCC 017

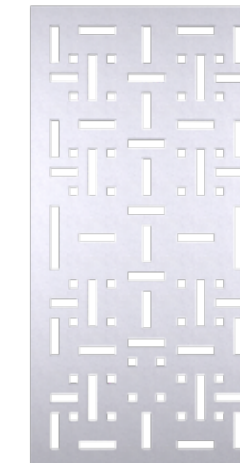

SCC 018

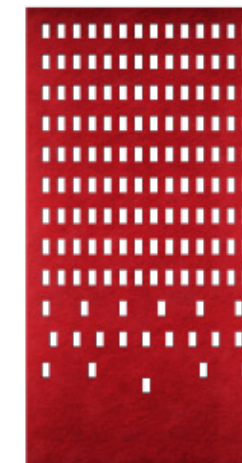

SCC 019



Los paneles con corte V de Sonara tienen diseños listos para crear un interior contemporáneo y dando flexibilidad de diseño en cualquier entorno.

PANEL TIPO
CORTE V



SRV 003

Corte V

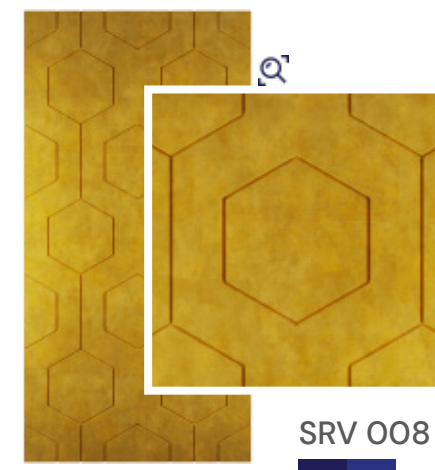
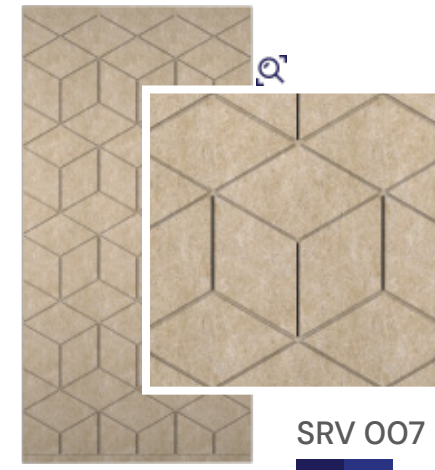
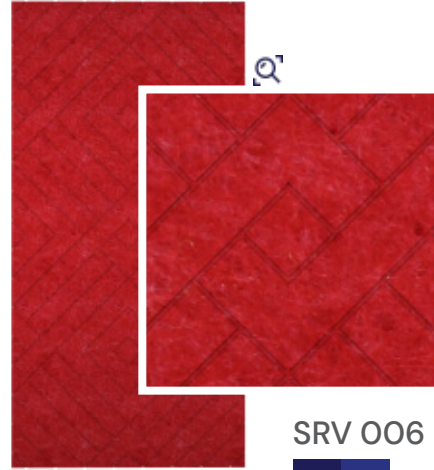
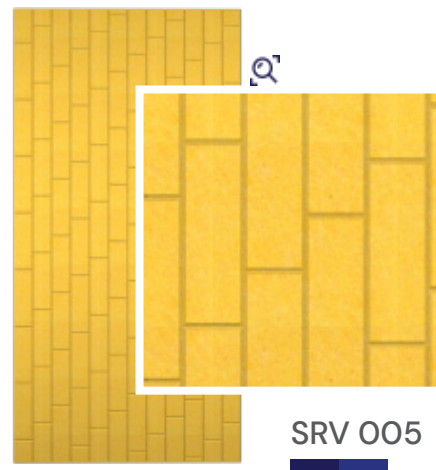
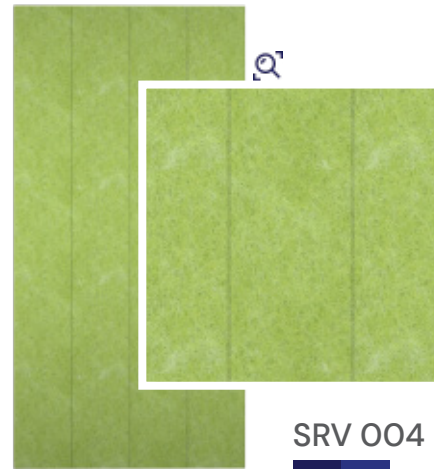
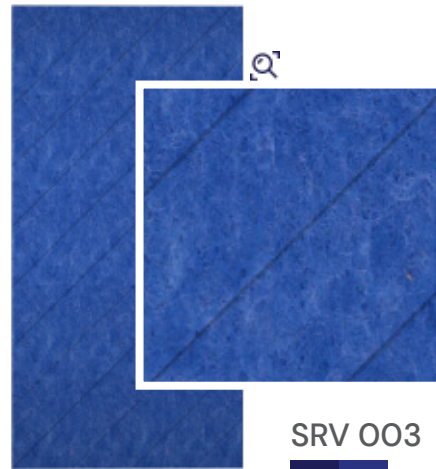
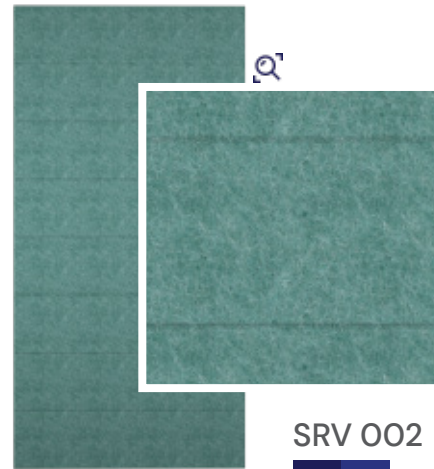
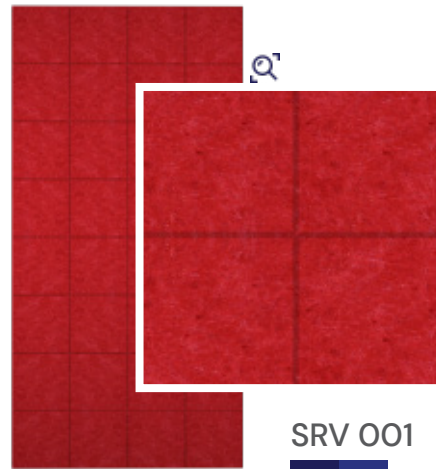

Los paneles con desbaste en U son ideales para destacar muros y techos, estos pueden llevar acabados rectos y curvos.

PANEL TIPO
CORTE U



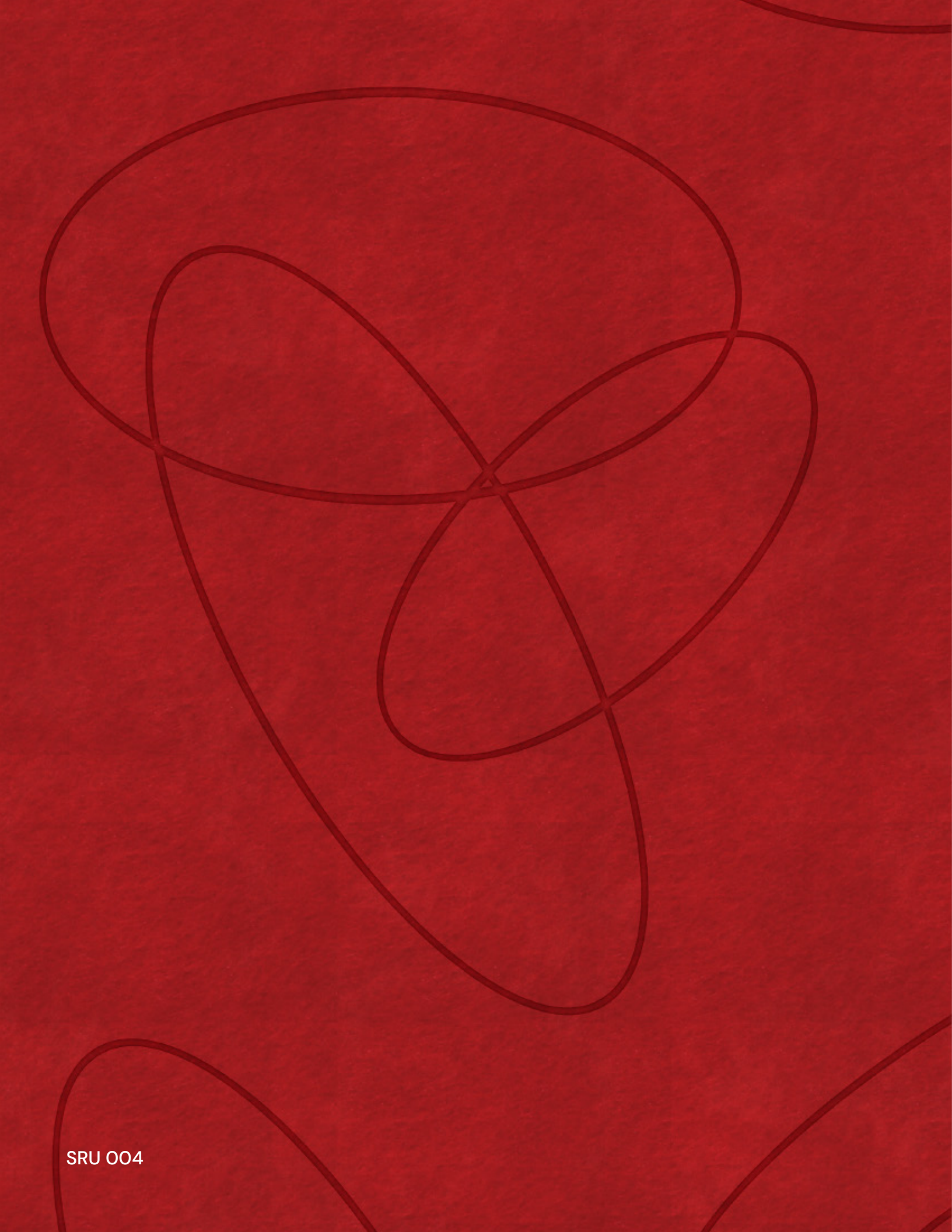

Corte U

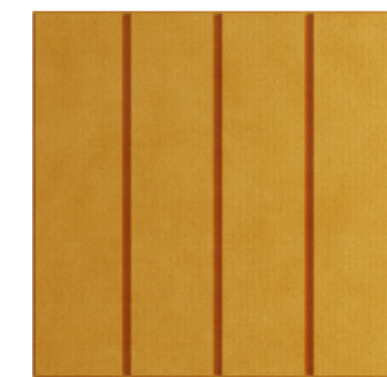
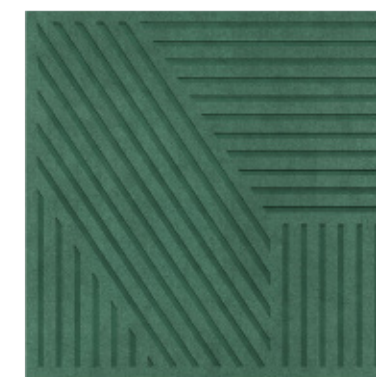
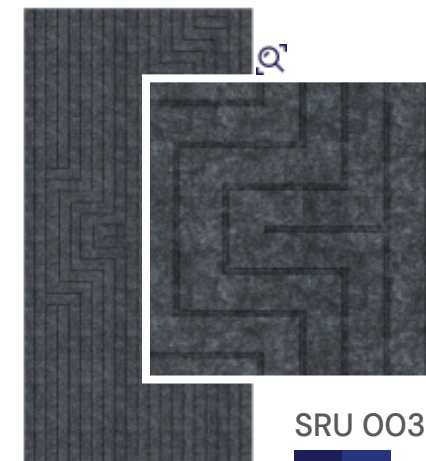
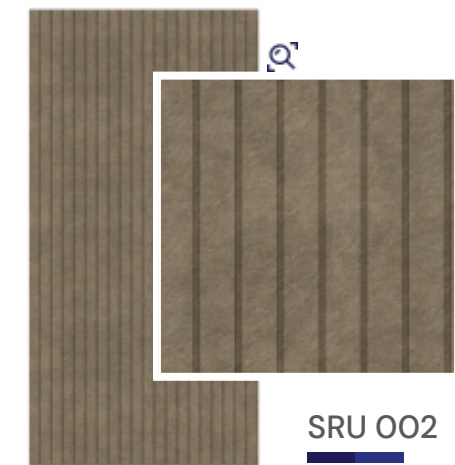
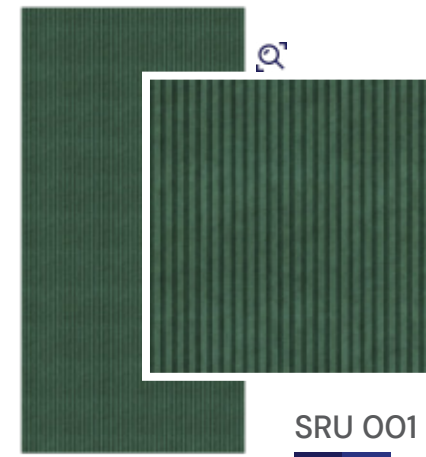

SRU 004



Corte U



SRU 007



SRU 008



SRU 009



SRU 010

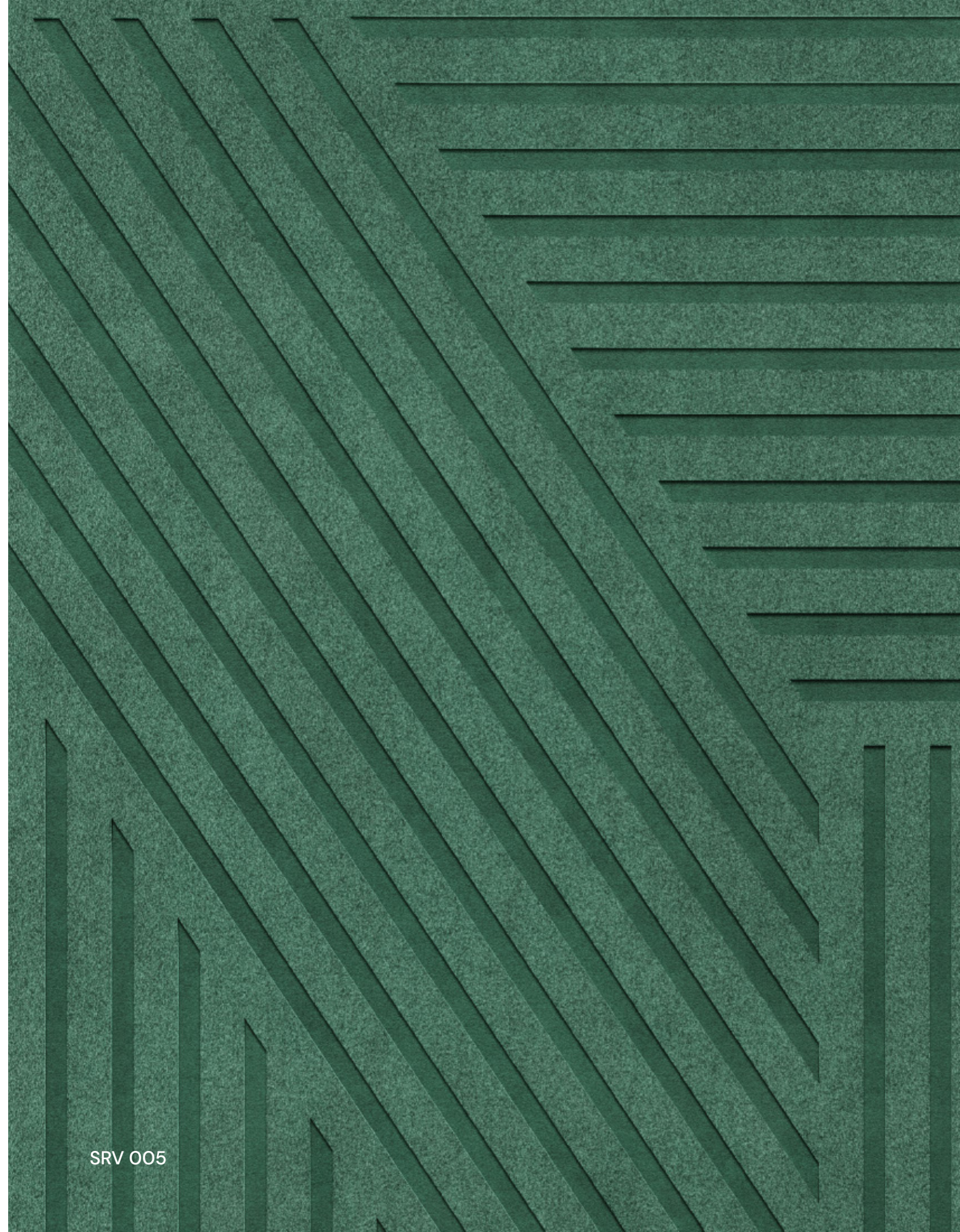

SRV 005



Contamos con corte de figuras ya definidas las cuales pueden ser utilizadas como celosías, decoraciones, colocar sobre otro panel, etc.

SONARA
SHAPES



HEXÁGONO 30 cms.

Shapes

CÍRCULO

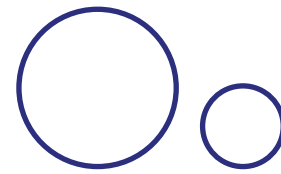

Medidas:
· Diámetro de 30 cms.
· Diámetro de 60 cms.

CUADRADO

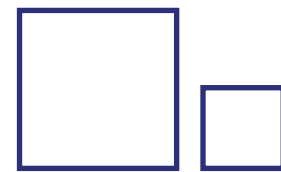
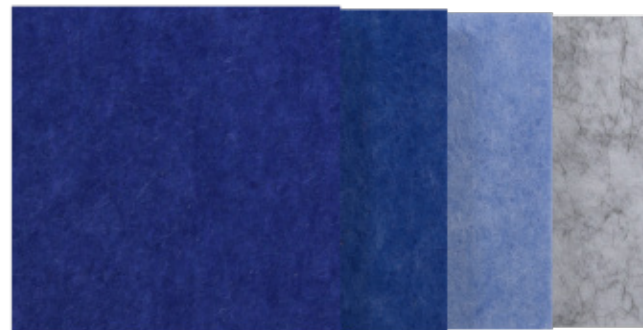

Medidas:
30 y 60 cms.

HEXÁGONO

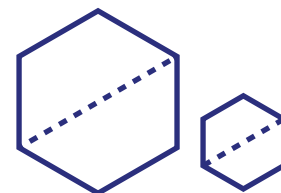

Medidas:
· Interior de 60 cms. y lados de 30 cms. c/u
· Interior de 30 cms. y lados de 15 cms. c/u



Shapes

TRIÁNGULO



Medidas:
· 60 x 60 x 85 cms.
· 30 x 30 x 42 cms.

RECTÁNGULO

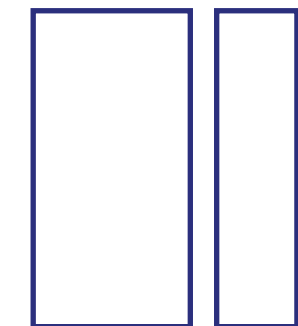
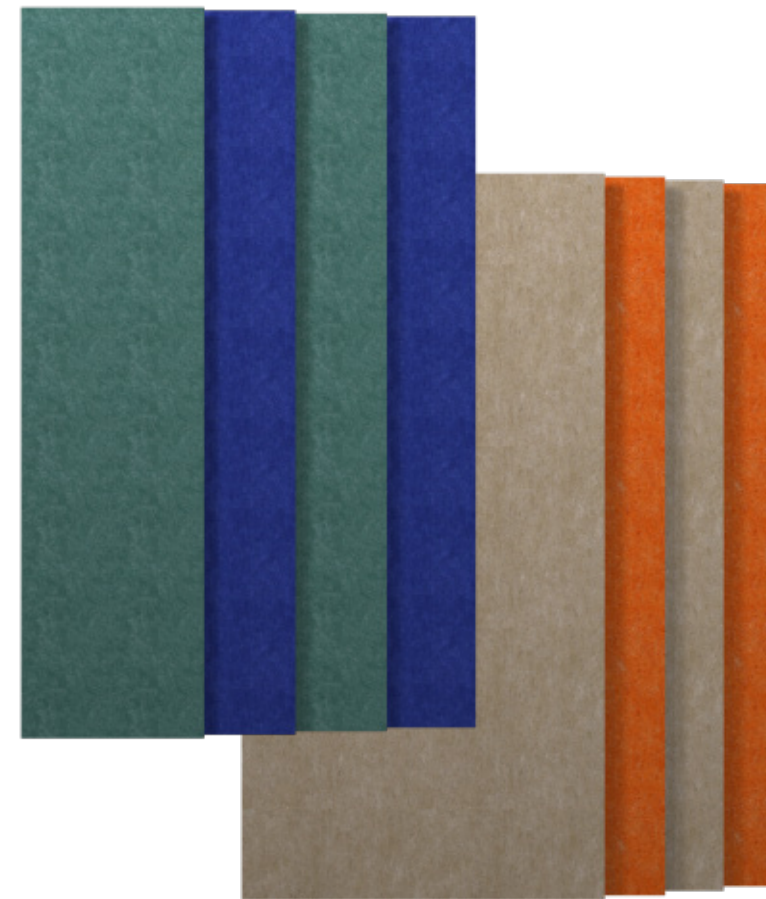

Medidas:
· 120 x 60 cms.
· 120 x 30 cms.







SACC 005

Con los diseños variados apoyamos a complementar su idea, mientras ayuda a los ocupantes de la habitación a comunicarse de forma libre y creativa. Este tipo de solución es completamente funcional, ya que la superficie del panel acústico Sonara absorbe el sonido, reduciendo el eco y mejorando la comunicación.

SONARA
**PANELES
 SUSPENDIDOS**

Paneles Suspendidos

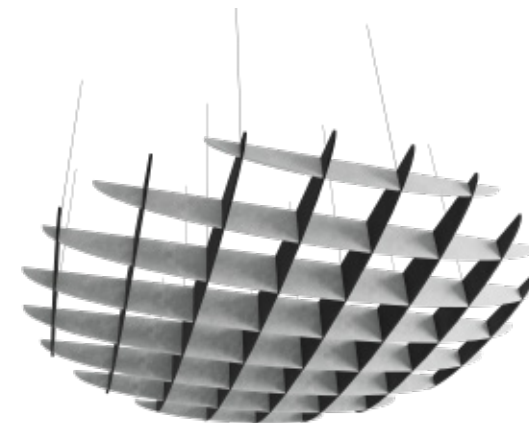

SACC 003

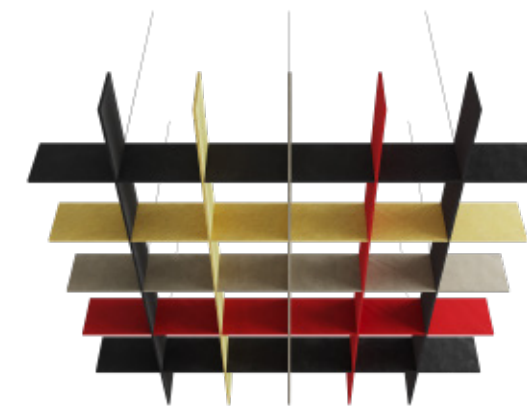

SACC 004

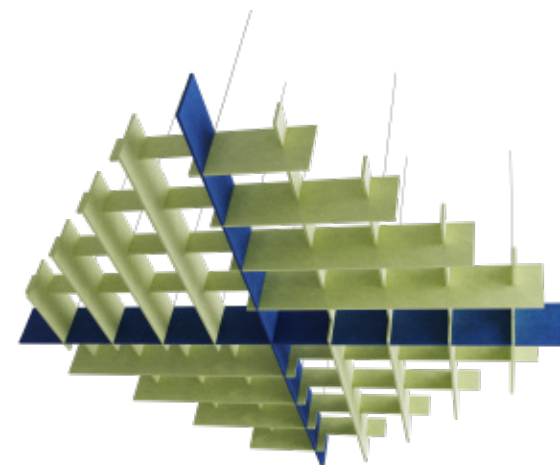

SACC 005



SACC 006





SACC 002

SONARA
ACCESORIOS

Accesorios

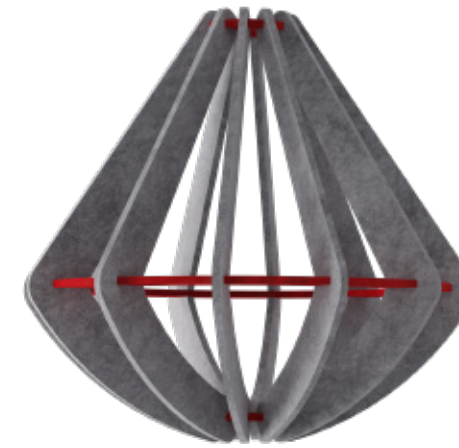

SACC 001

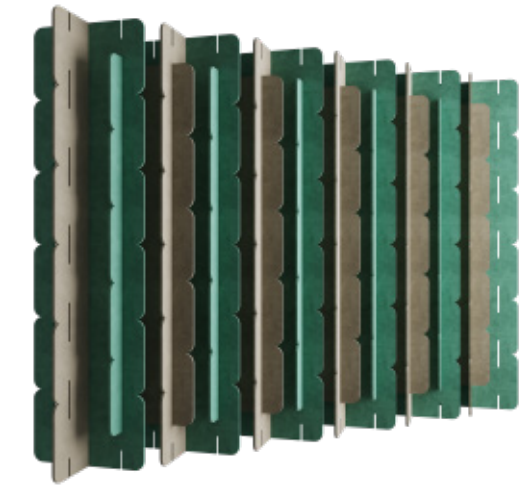

SACC 002



ACCESORIOS DE INSTALACIÓN

Herrajes para suspender paneles en horizontal y vertical

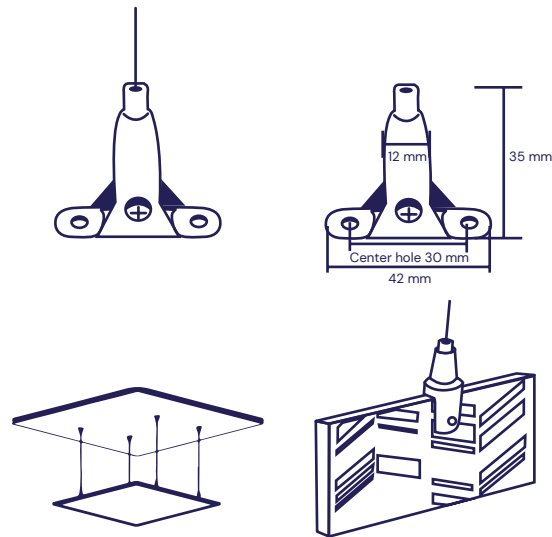

Pegamento para colocar paneles en pared

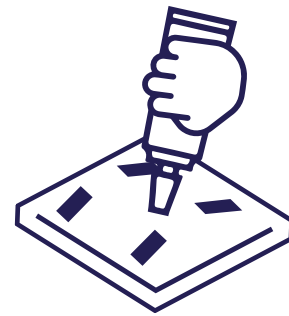

GARANTÍA

Todas las Soluciones Sonara y herrajes cuentan con 5 años de garantía por defectos de fábrica

TIEMPOS DE ENTREGA

Sonara Panel

3 días hábiles

Sonara Shapes
Corte Celosía, U y V

3 - 5 días hábiles

Sonara Custom

10 días hábiles

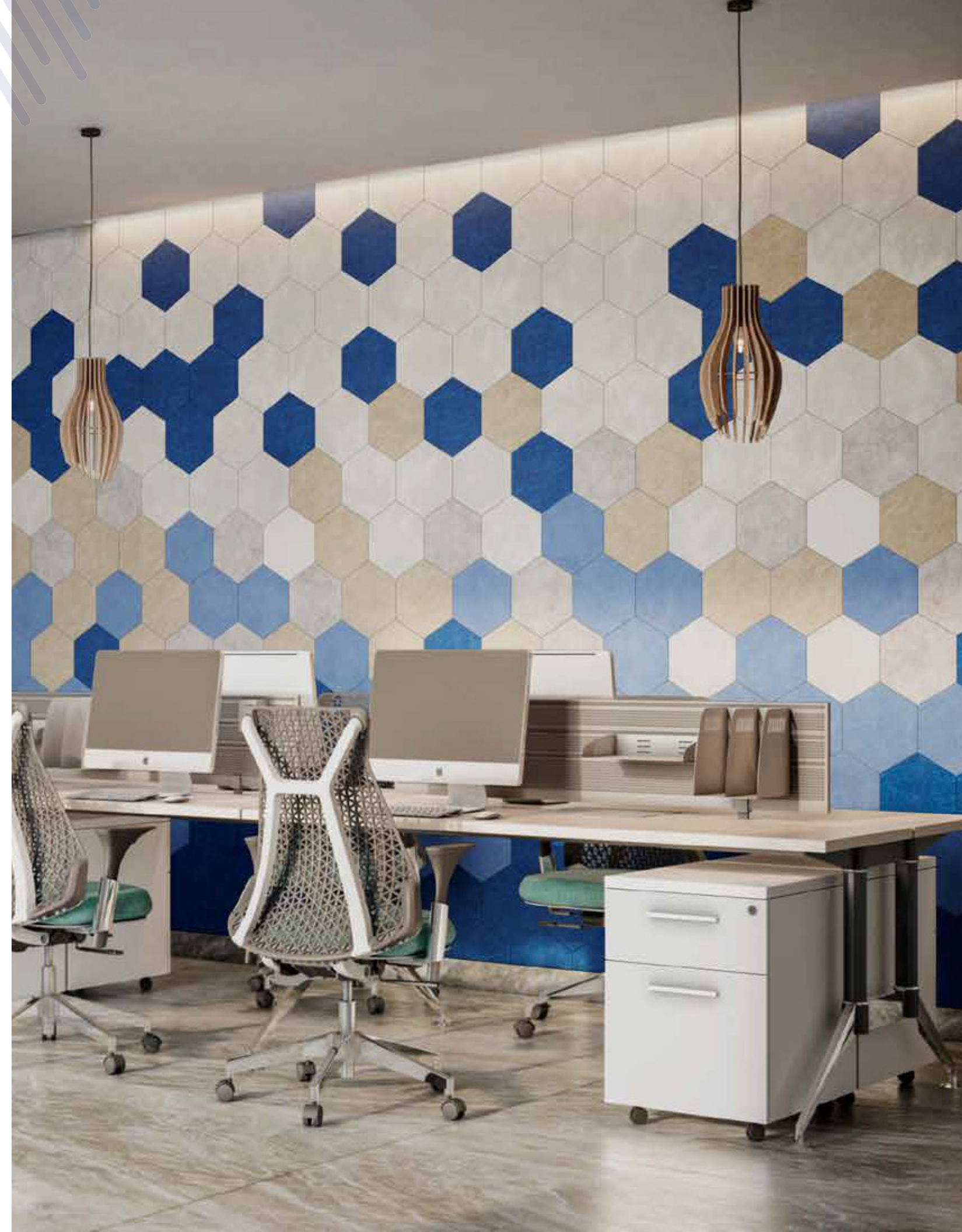

sOnara



cillo.mx